

ROHS
Compatible

RECOMMENDED OPENING DIMENSIONS OF CASE MATING
AREA WITHS EALING RING

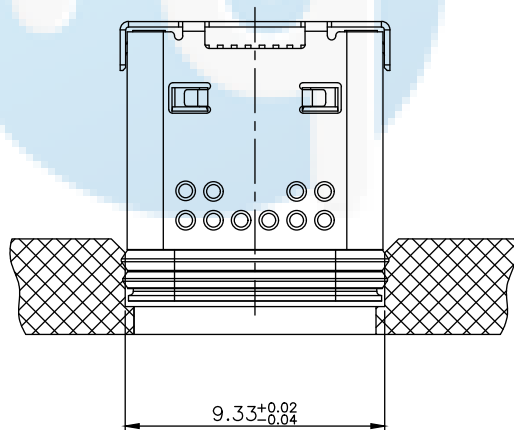

SECTION X-X

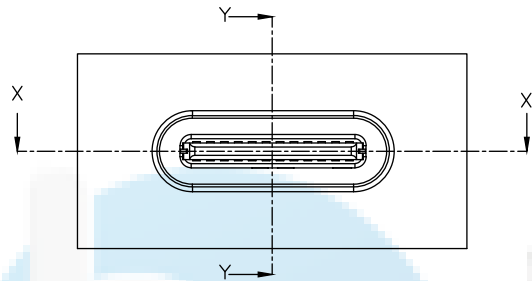
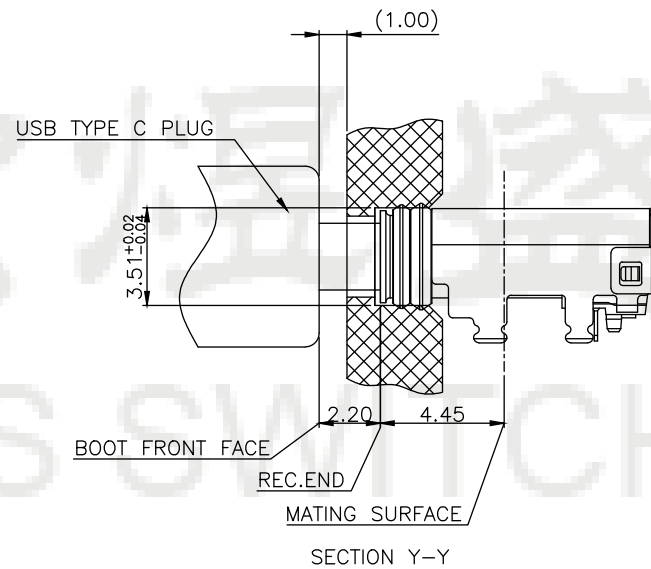

SECTION Y-Y

DESIGN	Li Jinwei	SCALL		 TOLERANCE X.X ±0.30 X.°±2° .XX ±0.20 .X° ±1° .XXX ±0.10 .XX°±0.5°	DRAWG NO.	U5198-24PN10.5LF
DRAWING	Wu Qifa	UNIT	mm		TITLE:	防水24P 板上六脚插板DIP + SMT带柱10.05L IPX7
CHECK	Zheng Jinxian	SIZE	A4: 210 * 297			
APPROVAL	Liu Xiaohong	DATE	2020-06-10			



东莞市宏煜盛实业有限公司
Dongguan hongyusheng Industry Co., Ltd
TEL: 0769-81230179 <https://www.hystypec.com>

ROHS
Compatible

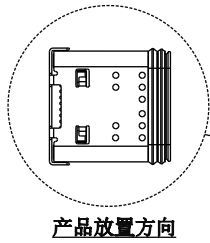

产品收料示意图

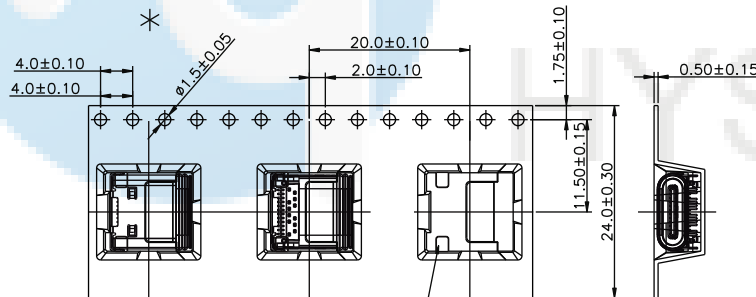
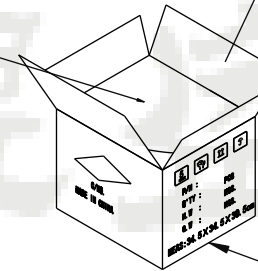
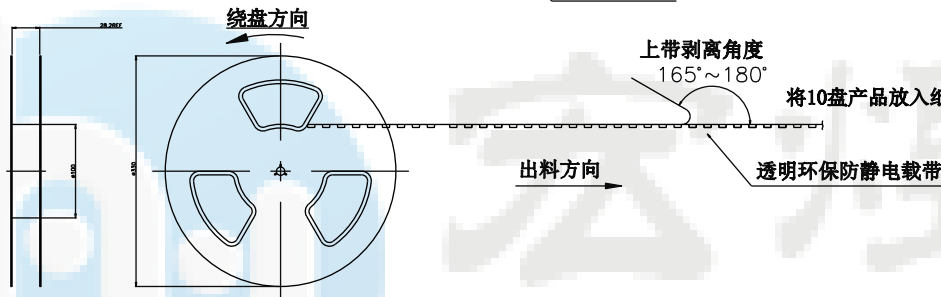
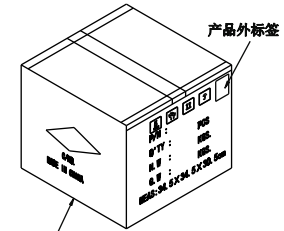
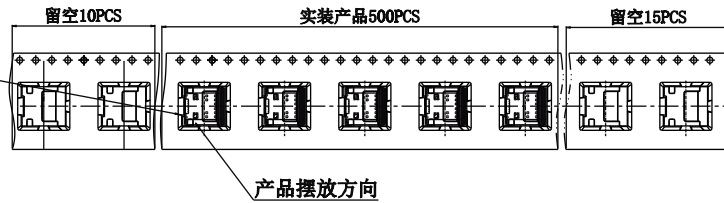

凸台不可缺失, 变形

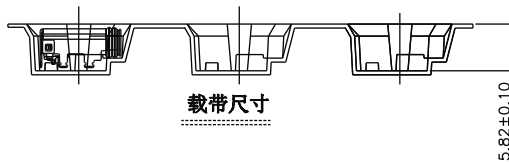

技术要求:

1. 上圆孔十个孔距离累计允许公差为±0.2mm;
2. 带长250mm内容许弯曲度1mm;
3. 材料: 透明PS, T=0.50±0.05mm;
4. 卷轮为覆胶卷轮: 外径φ330mm+轴径φ100mm
5. 环保: 材料需符合ROHS+无卤要求;
6. 单卷可装粒数: 500pcs+前留空15pcs, 后留空10pcs, 真空包装。
7. 每卷由供应商搭配卷盘包装一并供货。
8. 载带需参考产品出料方向绕盘, 避免我司重复倒盘。
9. 产品放置载带中不可有严重晃动, 不可对产品产生变形等其他不良。
10. 标*尺寸为关键配合尺寸。
11. 在卷装OK的每卷盘面的指定位置上贴物料和RoHS标签装入纸箱内; 每箱装10盘, 总数5000PCS

DESIGN	Li Jinwei	SCALL		 TOLERANCE X.X ±0.30 X.°±2° .XX ±0.20 .X°±1° .XXX ±0.10 .XX°±0.5°	DRAWG NO.	U5198-24PN10.5LF
DRAWING	Wu Qifa	UNIT	mm		TITLE:	防水24P 板上六脚插板DIP + SMT带柱10.05L IPX7
CHECK	Zheng Jinxian	SIZE	A4: 210 * 297			
APPROVAL	Liu Xiaohong	DATE	2020-06-10			



东莞市宏煜盛实业有限公司
Dongguan hongyusheng Industry Co., Ltd
TEL: 0769-81230179 <https://www.hystypec.com>