

**ROHS**  
Compatible

NOTES

1. CURRENT RATING: 1A.
2. CONTACT RESISTANCE: 100mΩ MAX.
3. INSULATION RESISTANCE: 100MΩ MIN.
4. DIELECTRIC WITHSTANDING: 500V AC MIN.
5. DURABILITY: 5000 CYCLES MIN.
6. CONNECTOR MATING FORCES: 30N MAX.
7. CONNECTOR UNMATING FORCES: 3N MIN.

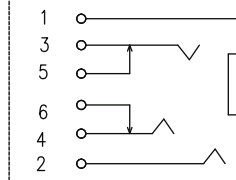
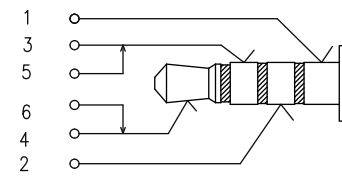
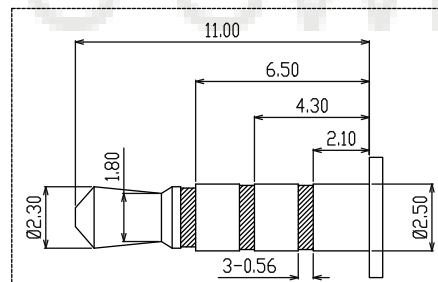
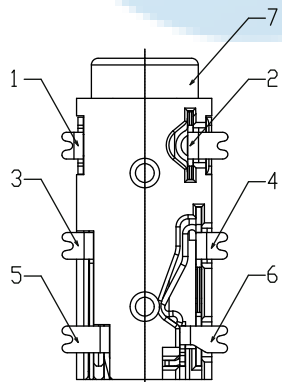
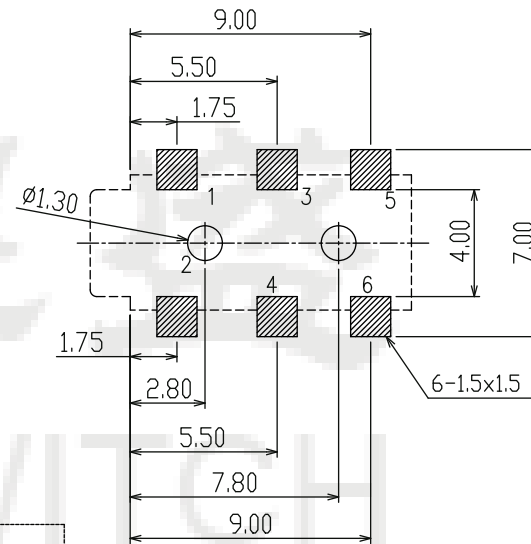
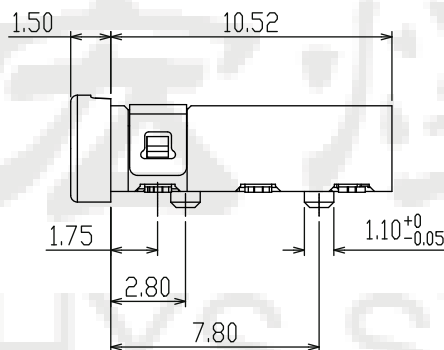
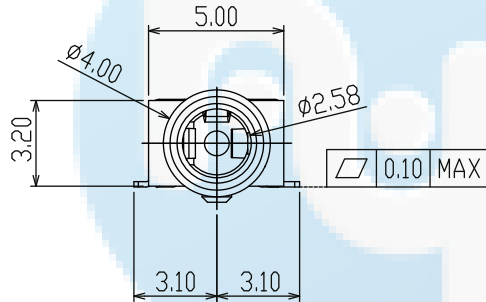
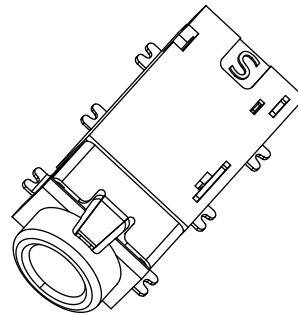
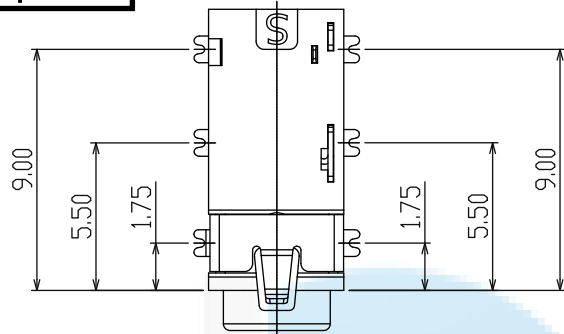

7	HOUSING 50mm 4 POLE PLUG TEMPERATURE: BLACK	Ø2.50mm 4 POLE PLUG SCHEMATIC	SCHEMATIC
6	TERMINAL 6#	1	PHOSPHOR BRONZE; NICKEL UNDERPLATING OVERALL, GOLD FLASH PLATING ON THE SOLDER & CONTACT AREA
5	TERMINAL 5#	1	PHOSPHOR BRONZE; NICKEL UNDERPLATING OVERALL, GOLD FLASH PLATING ON THE SOLDER & CONTACT AREA
4	TERMINAL 4#	1	STAINLESS STEEL; NICKEL UNDERPLATING OVERALL, GOLD FLASH PLATING ON THE SOLDER & CONTACT AREA
3	TERMINAL 3#	1	PHOSPHOR BRONZE; NICKEL UNDERPLATING OVERALL, GOLD FLASH PLATING ON THE SOLDER & CONTACT AREA
2	TERMINAL 2#	1	PHOSPHOR BRONZE; NICKEL UNDERPLATING OVERALL, GOLD FLASH PLATING ON THE SOLDER & CONTACT AREA
1	TERMINAL 1#	1	PHOSPHOR BRONZE; NICKEL UNDERPLATING OVERALL, GOLD PLATING ON THE WHOLE

DESIGN	Li Jinwei	SCALL		 <b>TOLERANCE</b> X.X ±0.30 X.°±2° .XX ±0.20 .X°±1° .XXX ±0.10 .XX°±0.5°
DRAWING	Wu Qifa	UNIT	mm	
CHECK	Zheng Jinxian	SIZE	A4: 210 * 297	
APPROVAL	Liu Xiaohong	DATE	2020-06-10	

DRAWG NO.	PJ-401A-2.5
TITLE:	Ø2.5mm 耳机插座全贴

**东莞市宏煜盛实业有限公司**  
 Dongguan hongyusheng Industry Co., Ltd  
 TEL: 0769-81230179 <https://www.hystypec.com>