

ROHS
Compatible

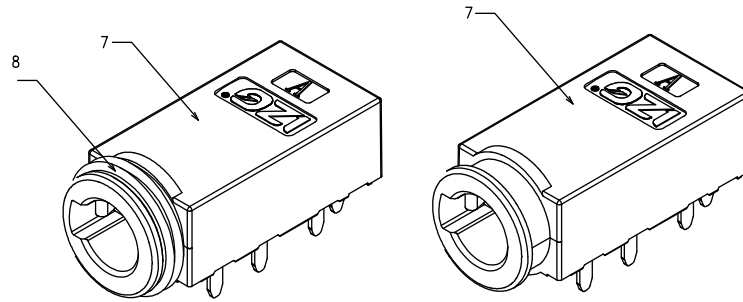

带防水圈 3D VIEW 不带防水圈

- CONTACT CURRENT RATING: 1A.
- CONTACT RESISTANCE: 100 mΩ MAX.;
- INSULATION RESISTANCE: 100MΩ MIN.;
- DIELECTRIC WITHSTANDING: 500V AC MIN.;
- DURABILITY: 5,000 CYCLES MIN.;
- CONNECTOR MATING FORCES: 30N MAX.;
- CONNECTOR UNMATING FORCES: 3N MIN.;
- TERPROOF LEVEL: IP67;

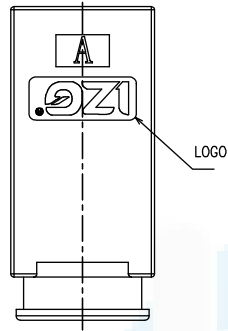

LOGO

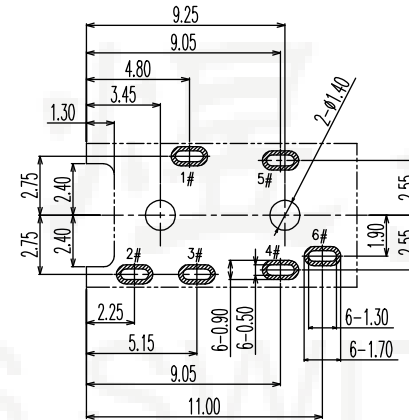
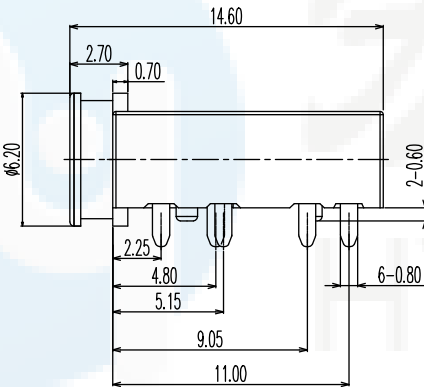
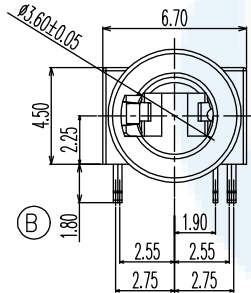

P.C.B LAYOUT T=1.00mm
TOP VIEW

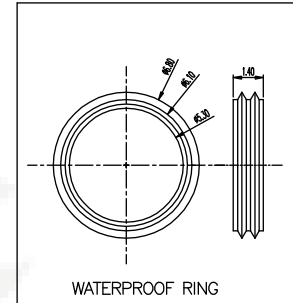

WATERPROOF RING

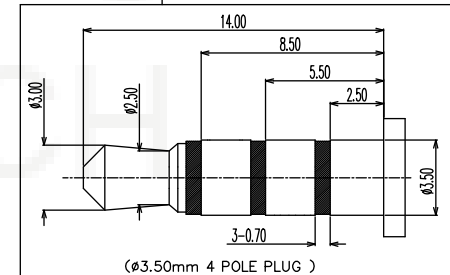

(Φ3.50mm 4 POLE PLUG)

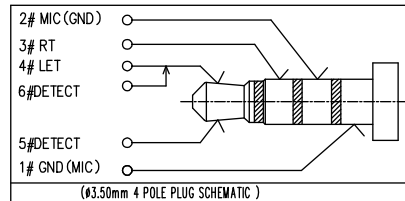
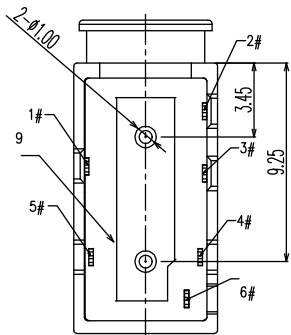

(Φ3.50mm 4 POLE PLUG SCHEMATIC)

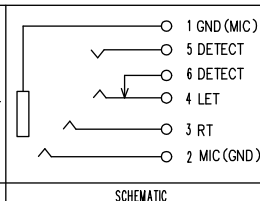

SCHEMATIC

ITEM	NAME	Q'TY	DESCRIPTION	NOTE
9	COVER	1	HIGH TEMPERATURE PLASTIC MATERIALE; COLOR BLACK	
8	WATERPROOF RING	1	SILICA GEL	
7	HOUSING	1	HIGH TEMPERATURE PLASTIC MATERIALE; COLOR BLACK	
6	TERMINAL 6#	1	COPPER ALLOY; NICKEL UNDER PLATING OVERALL;GOLD FLASH PLATING ON SOLDER AREA ;GOLD FLASH PLATING ON CONTACT AREA	T=0.20mm
5	TERMINAL 5#	1	COPPER ALLOY; NICKEL UNDER PLATING OVERALL;GOLD FLASH PLATING ON SOLDER AREA ;GOLD FLASH PLATING ON CONTACT AREA	T=0.20mm
4	TERMINAL 4#	1	COPPER ALLOY; NICKEL UNDER PLATING OVERALL;GOLD FLASH PLATING ON SOLDER AREA ;GOLD FLASH PLATING ON CONTACT AREA	T=0.20mm
3	TERMINAL 3#	1	COPPER ALLOY; NICKEL UNDER PLATING OVERALL;GOLD FLASH PLATING ON SOLDER AREA ;GOLD FLASH PLATING ON CONTACT AREA	T=0.20mm
2	TERMINAL 2#	1	COPPER ALLOY; NICKEL UNDER PLATING OVERALL;GOLD FLASH PLATING ON SOLDER AREA ;GOLD FLASH PLATING ON CONTACT AREA	T=0.20mm
1	TERMINAL 1#	1	STAINLESS STEEL; NICKEL UNDER PLATING OVERALL;GOLD FLASH PLATING ON SOLDER AREA ;GOLD FLASH PLATING ON CONTACT AREA	T=0.20mm

DESIGN	Li Jinwei	SCALL		
DRAWING	Wu Qifa	UNIT	mm	
CHECK	Zheng Jinxian	SIZE	A4: 210 * 297	
APPROVAL	Liu Xiaohong	DATE	2020-06-10	

DRAWG NO.	PJ-431F
TITLE:	Φ3.5mm防水耳机插座(左声道开关检测功能)

东莞市宏煜盛实业有限公司
 Dongguan hongyusheng Industry Co., Ltd
 TEL: 0769-81230179 <https://www.hystypec.com>