

**ROHS**  
Compatible

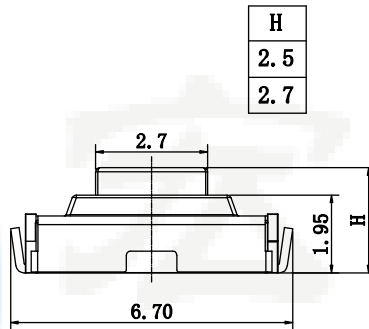

主要技术规格:

1. 额定值: 50mA DC12V
2. 接触电阻:  $\leq 100m\Omega$
3. 操作力:  $250 \pm 40gf$
4. 行程:  $0.20 \pm 0.1mm$
5. 绝缘电阻:  $\geq 100M\Omega$
6. 抗电强度: 250V 50HZ 1Min.
7. 寿命: 20,000 Cycles

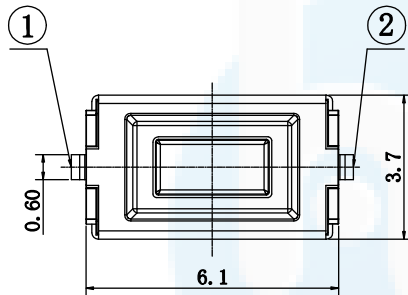
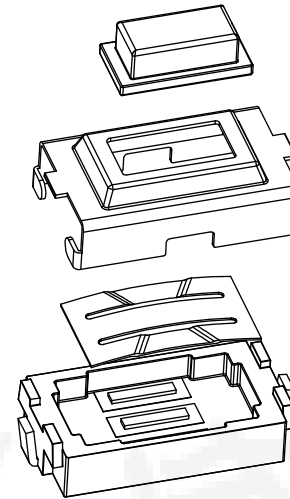
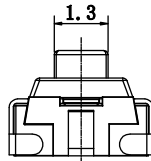
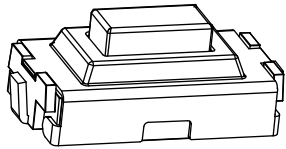
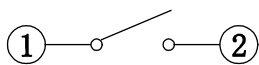

电路图

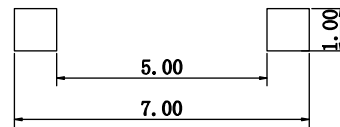

PCB. 焊接图

材料:

- 本体: PPA (黑色)
- 按钮: PPA (白色)
- 卡件: 黄铜 (镀银)
- 弹片: 不锈钢 (覆银)
- 盖板: 不锈钢

DESIGN	Li Jinwei	SCALL		 TOLERANCE X.X $\pm 0.30$ X. $^{\circ} \pm 2^{\circ}$ .XX $\pm 0.20$ .X. $^{\circ} \pm 1^{\circ}$ .XXX $\pm 0.10$ .XX. $^{\circ} \pm 0.5^{\circ}$	DRAWG NO.	HYS-149
DRAWING	Wu Qifa	UNIT	mm		TITLE:	
CHECK	Zheng Jinxian	SIZE	A4: 210 * 297			
APPROVAL	Liu Xiaohong	DATE	2020-06-10			



**东莞市宏煜盛实业有限公司**  
Dongguan hongyusheng Industry Co., Ltd  
TEL: 0769-81230179 <https://www.hystypec.com>