

ROHS
Compatible

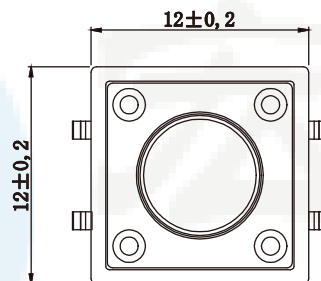

主要技术规格:

1. 额定值: 50mA DC12V
2. 接触电阻: $\leq 50m\Omega$
3. 操作力: $250 \pm 40gf$
4. 行程: $0.35 \pm 0.1mm$
5. 绝缘电阻: $\geq 100M\Omega$
6. 抗电强度: 250V 50HZ 1Min.
7. 寿命: 100,000 Cycles

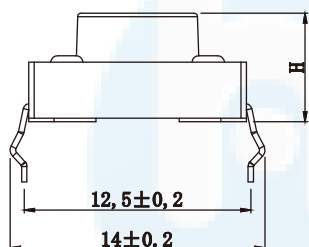
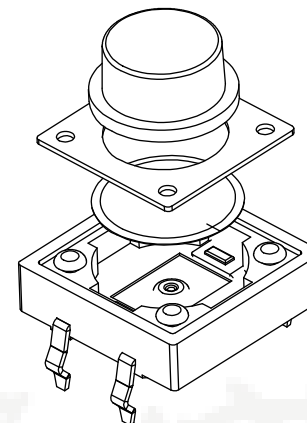
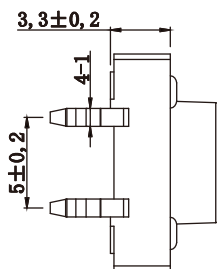
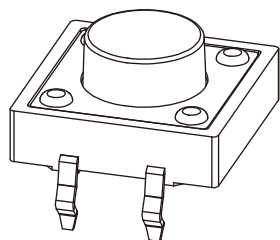
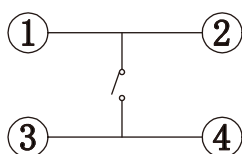

电路图

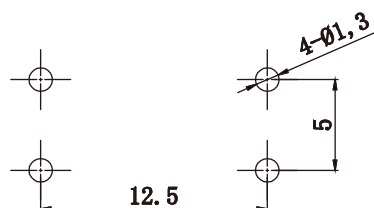

PCB. 焊接图

5	引脚、触点	黄铜	1	镀银
4	基座	PPA	1	耐温280℃ (黑色)
3	簧片	不锈钢	1	覆银
2	盖板	冷轧钢	1	镀锡
1	按钮	PPA	1	耐温280℃ (黑色)
序号	零件名称	材料规格	数量	备注

DESIGN	Li Jinwei	SCALL		 TOLERANCE X.X ±0.30 X.°±2° .XX ±0.20 .X°±1° .XXX ±0.10 .XX°±0.5°	DRAWG NO.	HYS-1161
DRAWING	Wu Qifa	UNIT	mm		TITLE:	轻触开关四脚插件 12*12*H
CHECK	Zheng Jinxian	SIZE	A4: 210 * 297			
APPROVAL	Liu Xiaohong	DATE	2020-06-10			

东莞市宏煜盛实业有限公司
 Dongguan hongyusheng Industry Co., Ltd
 TEL: 0769-81230179 <https://www.hystypec.com>