

ROHS
Compatible

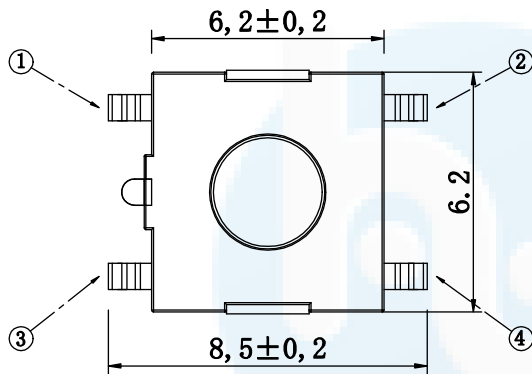

| H | |
|-----|-----|
| 3.1 | 3.5 |
| 4.3 | 4.5 |
| 5.0 | |

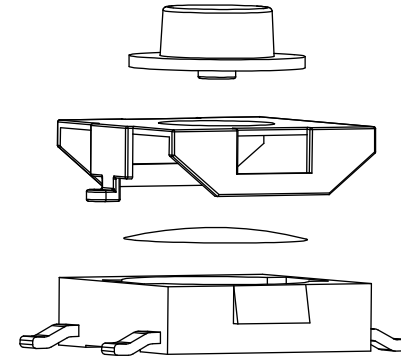
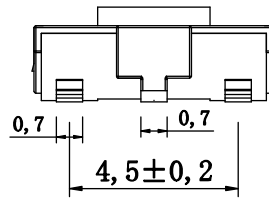
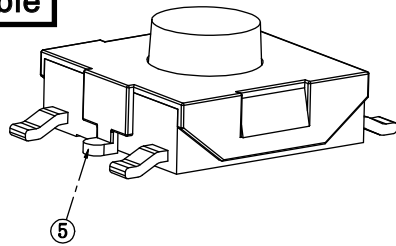
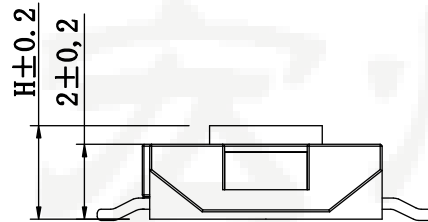

主要技术规格:

1. 额定值: 50mA DC12V
2. 接触电阻: $\leq 100m\Omega$
3. 操作力: $250 \pm 50gf$
4. 行程: $0.25 \pm 0.1mm$
5. 绝缘电阻: $\geq 100M\Omega$
6. 抗电强度: 250V 50HZ 1Min.
7. 寿命: 100,000 Cycles

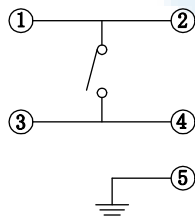

电路图

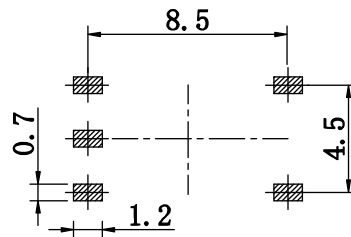

PCB. 焊接图

| 5 | 引脚、触点 | 黄铜 | 1 | 镀银 |
|----|-------|------|----|---------|
| 4 | 基座 | PPA | 1 | 耐高温280℃ |
| 3 | 簧片 | 不锈钢 | 1 | 覆银 |
| 2 | 盖板 | 磷铜 | 1 | 镀锡 |
| 1 | 按钮 | PPA | 1 | 耐高温280℃ |
| 序号 | 零件名称 | 材料规格 | 数量 | 备注 |

| | | | | |
|----------|---------------|-------|---------------|-------------------------------------------------------------------------------|
| DESIGN | Li Jinwei | SCALL | | TOLERANCE X.X ±0.30 X.°±2° .XX ±0.20 .X°±1° .XXX ±0.10 .XX°±0.5° |
| DRAWING | Wu Qifa | UNIT | mm | |
| CHECK | Zheng Jinxian | SIZE | A4: 210 * 297 | |
| APPROVAL | Liu Xiaohong | DATE | 2020-06-10 | |

DRAWG NO. HYS-1128
TITLE: 轻触开关五脚贴片6.2*6.2*H



东莞市宏煜盛实业有限公司
Dongguan hongyusheng Industry Co., Ltd
TEL: 0769-81230179 <https://www.hystypec.com>