

ROHS
Compatible

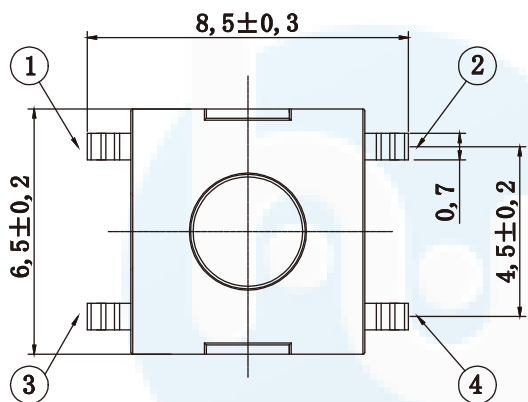

H	
3.1	3.5
4.3	4.5
5.0	

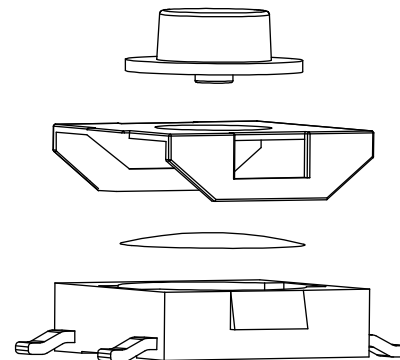
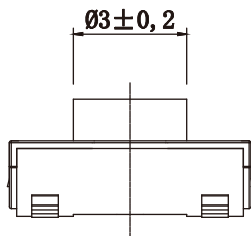
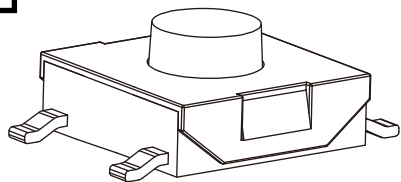
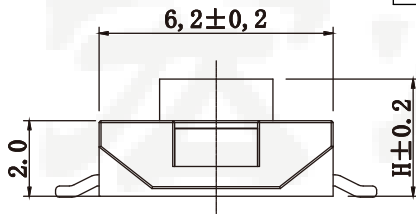

主要技术规格:

1. 额定值: 50mA DC12V
2. 接触电阻: $\leq 100m\Omega$
3. 操作力: $250 \pm 40gf$
4. 行程: $0.25 \pm 0.1mm$
5. 绝缘电阻: $\geq 100M\Omega$
6. 抗电强度: 250V 50HZ 1Min.
7. 寿命: 100,000 Cycles

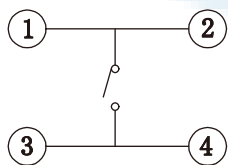

电路图

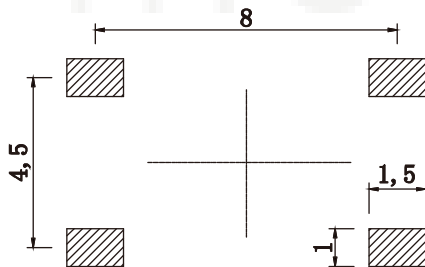

PCB. 焊接图

5	引脚、触点	黄铜	1	镀银
4	基座	PPA	1	耐温280℃
3	簧片	不锈钢	1	覆银
2	盖板	不锈钢	1	/
1	按钮	PPA	1	耐温280℃
序号	零件名称	材料规格	数量	备注

DESIGN	Li Jinwei	SCALL			DRAWG NO.	HYS-1127
DRAWING	Wu Qifa	UNIT	mm		TOLERANCE	
CHECK	Zheng Jinxian	SIZE	A4: 210 * 297	X.X ±0.30 X.°±2°		
APPROVAL	Liu Xiaohong	DATE	2020-06-10	.XX ±0.20 .X° ±1°		
				.XXX ±0.10 .XX° ±0.5°		



东莞市宏煜盛实业有限公司
Dongguan hongyusheng Industry Co., Ltd
TEL: 0769-81230179 <https://www.hystypec.com>