

ROHS
Compatible

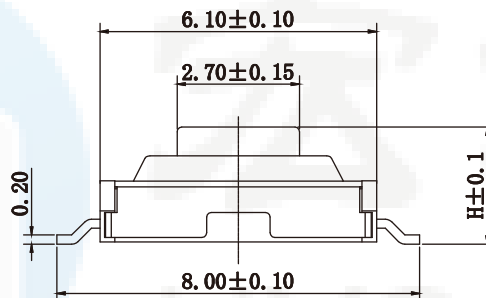
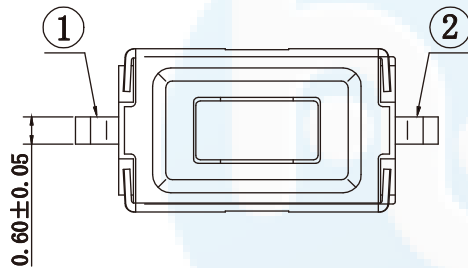
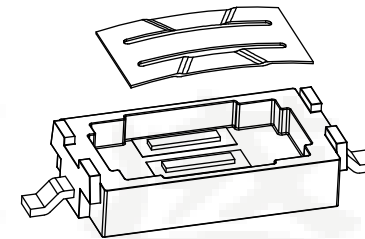
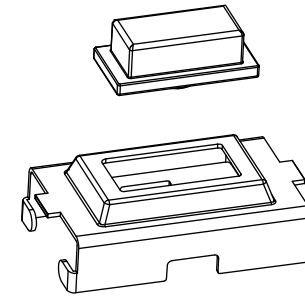
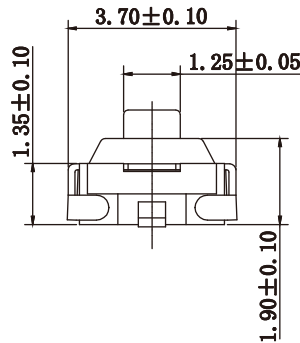
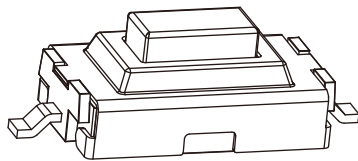

H
2.5
2.7

主要技术规格:

1. 额定值: 50mA DC12V
2. 接触电阻: $\leq 100\text{m}\Omega$
3. 操作力: $160 \pm 30\text{gf}$
4. 行程: $0.20 \pm 0.1\text{mm}$
5. 绝缘电阻: $\geq 100\text{M}\Omega$
6. 抗电强度: 250V 50HZ 1Min.
7. 寿命: 50,000 Cycles



电路图

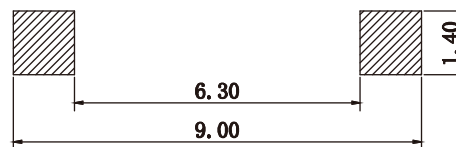

PCB. 焊接图

5	引脚、触点	黄铜	1	镀银
4	基座	PPA	1	耐温280℃ (黑色)
3	簧片	不锈钢	1	覆银
2	盖板	不锈钢	1	/
1	按钮	PPA	1	耐温280℃ (白色)
序号	零件名称	材料规格	数量	备注

DESIGN	Li Jinwei	SCALL		 TOLERANCE .XX ± 0.30 X. $^{\circ} \pm 2^{\circ}$.XX ± 0.20 .X. $^{\circ} \pm 1^{\circ}$.XXX ± 0.10 .XX. $^{\circ} \pm 0.5^{\circ}$
DRAWING	Wu Qifa	UNIT	mm	
CHECK	Zheng Jinxian	SIZE	A4: 210 * 297	
APPROVAL	Liu Xiaohong	DATE	2020-06-10	

DRAWG NO. HYS-148
TITLE: 轻触开关 3*6*2.5H一型拉伸



东莞市宏煜盛实业有限公司
Dongguan hongyusheng Industry Co., Ltd
TEL: 0769-81230179 <https://www.hystypec.com>