

**ROHS**  
Compatible

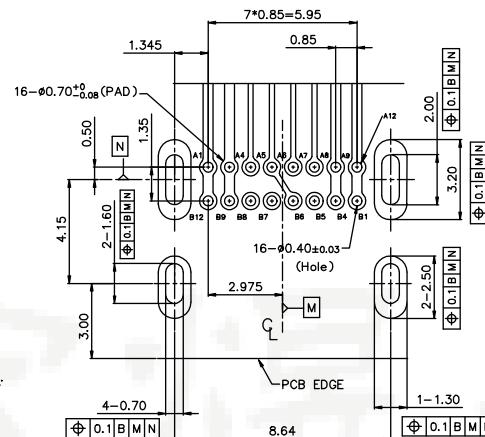

RECOMMENDED P.C.B LAYOUT  
GENERAL TOLERANCE: ±0.05  
PCB TOP SURFACE

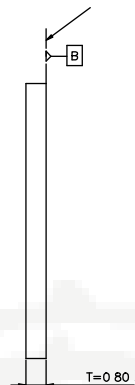
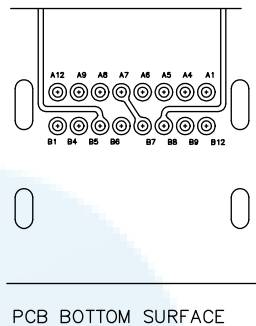
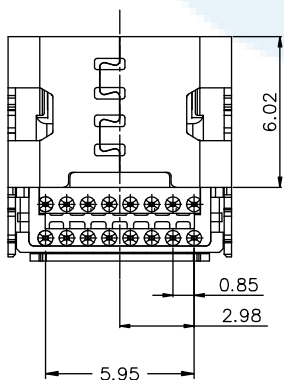
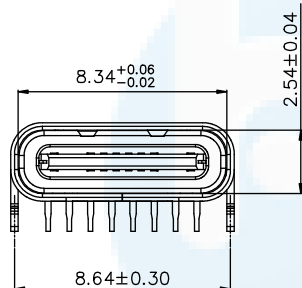
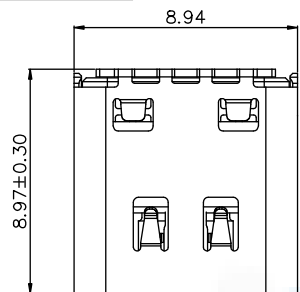
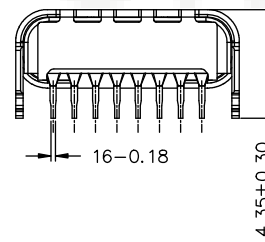
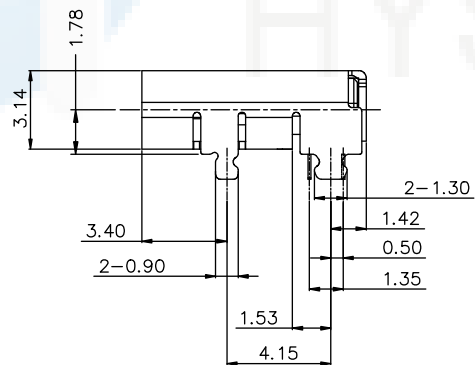

**备注:**

**1. 材质:**

- 1.1 胶芯: LCP+30%G.F
- 1.2 端子: C18140, T=0.12mm; 镍底, 镀金
- 1.3 外壳: 不锈钢, T=0.30mm; 表面镀镍
- 1.4 卡勾: 不锈钢, T=0.30mm;

**2. 主要特性:**

- 2.1 额定电流: 3.0A
- 2.2 接触阻抗: 40mΩ MAX
- 2.3 绝缘阻抗: 100MΩ MIN 250V DC
- 2.4 耐压测试: 100V AC
- 2.5 沾锡性: 温度250iA5℃, 时间5iA0.5s
- 2.6 整体插入力: 2.0kgf MAX  
整体拔出力: 0.6kgf MIN
- 2.7 使用寿命: 5000次
- 2.8 工作温度: -30℃~+80℃

**PIN ASSIGNMENT**

PIN NUMBER	SIGNAL NAME	PIN NUMBER	SIGNAL NAME
A1, A12, B1, B12	GND		
A2	SSTxp1	B11	SSRXp1
A3	SSTxn1	B10	SSRXn1
A4, A9, B4, B9	VBUS		
A5	CC1	B8	SBU2
A6	D+	B7	D-
A7	D-	B6	D+
A8	SBU1	B5	CC2
A10	SSRXn2	B3	SSTXn2
A11	SSRXp2	B2	SSTXp2

DESIGN	Li Jinwei	SCALL		 TOLERANCE X.X ±0.30 X.°±2° .XX ±0.20 .X°±1° .XXX ±0.10 .XX°±0.5°	DRAWG NO.	TYPE-C-DDT16P897
DRAWING	Wu Qifa	UNIT	mm		TITLE:	16P 四脚插板双排DIP带弹 8.97L
CHECK	Zheng Jinxian	SIZE	A4: 210 * 297			
APPROVAL	Liu Xiaohong	DATE	2020-06-10			



**东莞市宏煜盛实业有限公司**  
Dongguan hongyusheng Industry Co., Ltd  
TEL: 0769-81230179 <https://www.hystypec.com>