

ROHS
Compatible

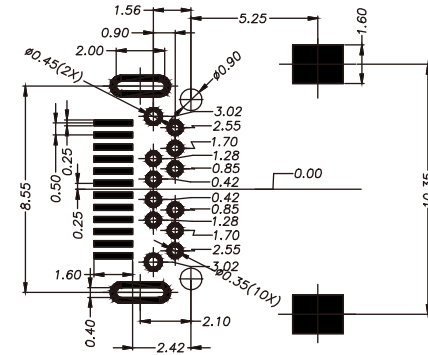

RECOMMENDED PCB LAYOUT(TOP VIEW)

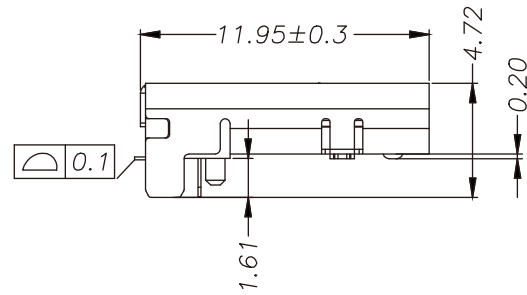
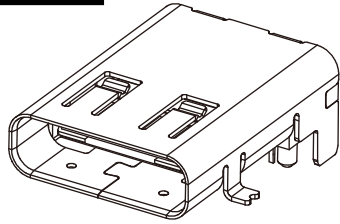
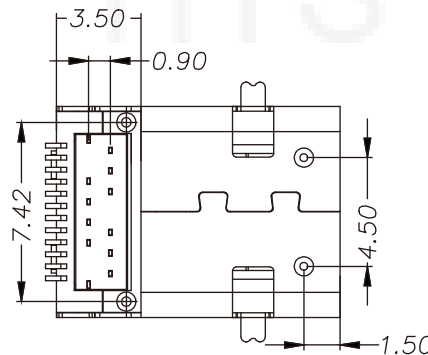
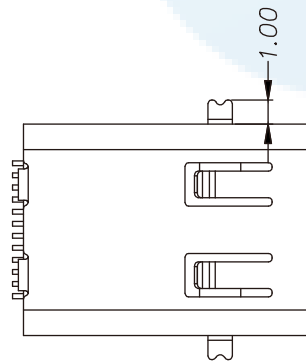
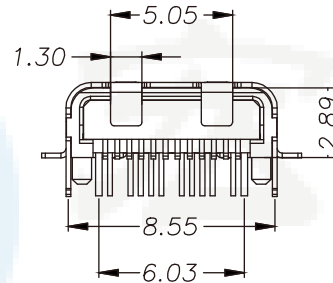
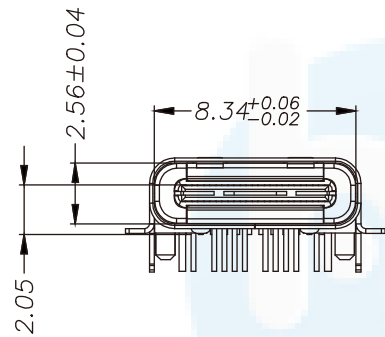

备注:

1. 材质:

1.1 胶芯: LCP+30%G.F UL94V-0

1.2 端子: 磷铜, T=0.12mm; 镍底, 镀金Xμ”

1.3 外壳: 不锈钢, T=0.30mm; 表面镀镍100μ”
或亮锡100μ”

1.4 接地片: 不锈钢, T=0.10mm;

1.5 卡片: 不锈钢, T=0.15mm;

2. 主要特性:

2.1 额定电流: 0.5A

2.2 接触阻抗: 30mΩ MAX

2.3 绝缘阻抗: 100MΩ MIN 250V DC

2.4 耐压测试: 250V AC

2.5 沾锡性: 温度250±5℃, 时间5±0.5s

2.6 整体插入力: 3.57kgf MAX

整体拔出力: 1.02kgf MIN

2.7 使用寿命: 10000次

2.8 工作温度: -30℃~+80℃

DESIGN	Li Jinwei	SCALL		 TOLERANCE X.X ±0.30 X.* ± 2. .XX ±0.20 .X.* ± 1. .XXX ±0.10 .XX.* ±0.5.	DRAWG NO.	TYPE-C-SDT24PZ1195
DRAWING	Wu Qifa	UNIT	mm		TITLE:	24P前贴后插DIP+SMT带弹L=11.95
CHECK	Zheng Jinxian	SIZE	A4: 210 * 297			
APPROVAL	Liu Xiaohong	DATE	2020-06-10			



东莞市宏煜盛实业有限公司
Dongguan hongyusheng Industry Co., Ltd
TEL: 0769-81230179 <https://www.hystypec.com>