

ROHS
Compatible

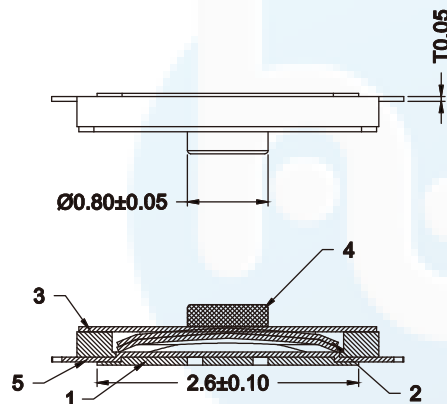

Circuit Diagram

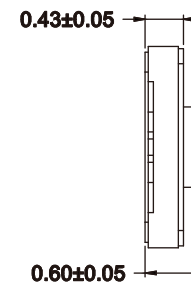
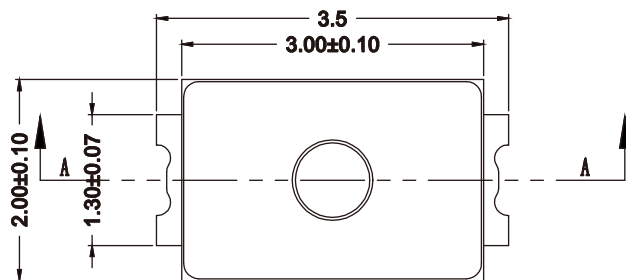
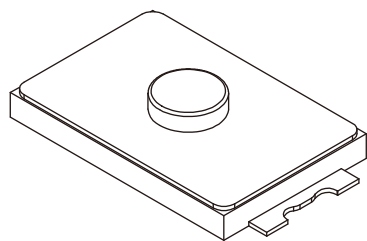
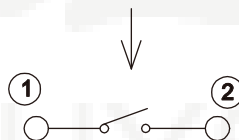

PCB layout

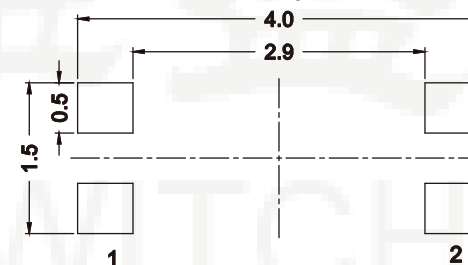

主要技术指标:

Main Specifications:

气候等级 Climate grade	额定值 Rated values	接触电阻 Contact resistance	耐压 Dielectric strength	绝缘电阻 Insulation resistance	行程 Travel	寿命 Life
-30℃~+85℃	Max50 mA12V Min10 μA1V DC	≤500mΩ	100V. AC. 1Min	≥100mΩ	0.18±0.05mm	300000次

序号	名称	数量	材料	备注
5	胶点	1	聚酰亚胺	黑色
4	端子	1	C5191	镀银
3	白膜	1	聚酰亚胺	白(透明)
2	弹片	2	SUS301-Ag0.5	单面镀银
1	塑胶底座	1	PA	黑色

DESIGN	Li Jinwei	SCALL		公差	Φ ±0.30 X.° ±2° .XX ±0.20 .X° ±1° .XXX ±0.10 .XX° ±0.5°
DRAWING	Wu Qifa	UNIT	mm	TOLERANCE	
CHECK	Zheng Jinxian	SIZE	A4: 210 * 297		
APPROVAL	Liu Xiaohong	DATE	2020-06-10		

DRAWG NO.	HYS-104
TITLE:	薄膜轻触开关 2*3*0.6H 白膜

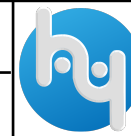

东莞市宏煜盛实业有限公司
Dongguan hongyusheng Industry Co., Ltd
TEL: 0769-81230179 <https://www.hystypec.com>