

ROHS
Compatible

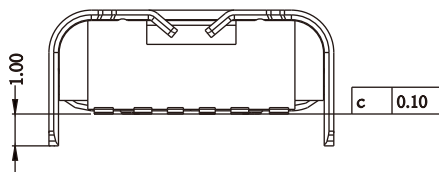
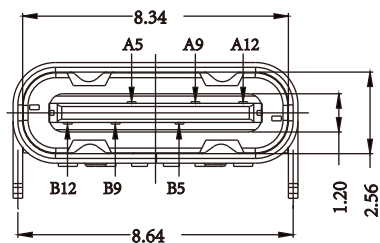
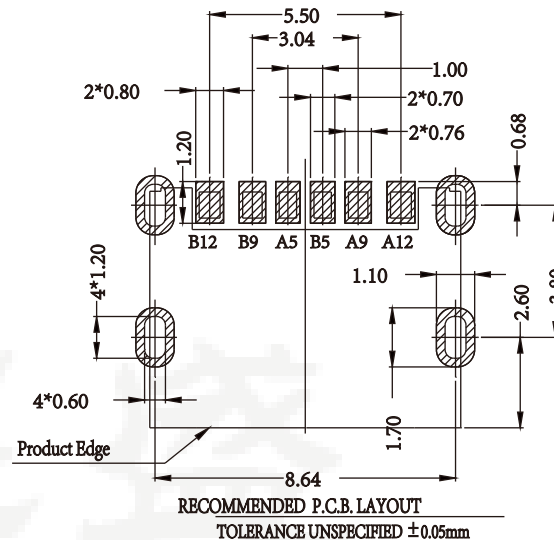
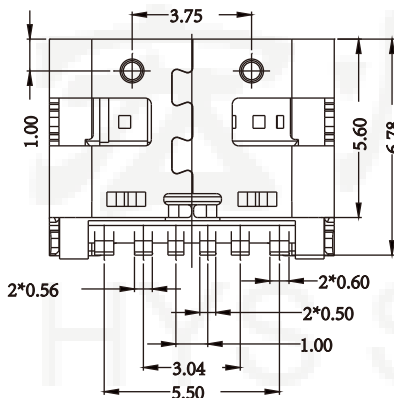
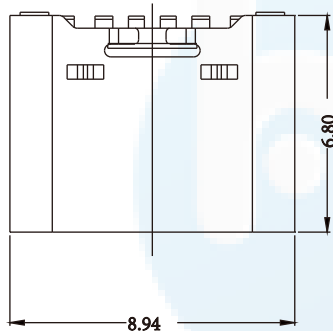
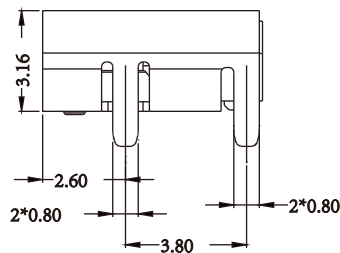
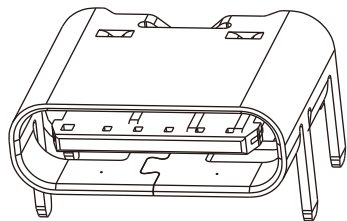

NOTES:

SPECIFICATION:

1. CURRENT RATING: 5.0A MAX
2. VOLTAGE: 100 VAC
3. TEMPERATURE RANGE: -30 ° C ~ 85 ° C
4. CONTACT RESISTANCE: 40 MILLIONHM MAX
5. INSULATION RESISTANCE: 100 MEGOHMS MIN.
6. INSERTION FORCE : 5N~20N
7. UNMATING FORCE: 8N~20N
8. DURABILITY: 10000 CYCLES

A5	CC1	B12	GND
A9	VBUS	B9	VBUS
A12	GND	B5	CC2
PIN	SIGNAL NAME	PIN	SIGNAL NAME

3	SHELL	STAINLESS STEEL	Ni80u * Plated	ISET
2	CONTACT	COPPER ALLOY	Au1u */Ni50u * Plated	ISET
1	HOUSING	HIGH TEMPERATURE PLASTIC	BLACK	IPCS
NO.	DESCRIPTION	MATERIAL	REMARKS	QTY

DESIGN	Li Jinwei	SCALL		 TOLERANCE X.X ±0.30 X.° ± 2° .XX ±0.20 .X° ± 1° .XXX ±0.10 .XX° ±0.5°
DRAWING	Wu Qifa	UNIT	mm	
CHECK	Zheng Jinxian	SIZE	A4: 210 * 297	
APPROVAL	Liu Xiaohong	DATE	2020-06-10	

DRAWG NO.	TYPE-C-DS06P10
TITLE:	单排6P 板上型 脚长1.0

东莞市宏煜盛实业有限公司
 Dongguan hongyusheng Industry Co., Ltd
 TEL: 0769-81230179 <https://www.hystypec.com>